

### FEATURES

- High resolution
- Dual-axis accelerometer on a single IC chip
- 5 mm × 5 mm × 2 mm LCC package
- Low power <math>< 400 \mu A</math> (typ)
- X-axis and Y-axis aligned to within 0.1° (typ)
- BW adjustment with a single capacitor
- Single-supply operation
- High shock survival

### APPLICATIONS

- Tilt and motion sensing
- Smart hand-held devices
- Computer security
- Input devices
- Pedometers and activity monitors
- Game controllers
- Toys and entertainment products

### GENERAL DESCRIPTION

The ADXL311 is a low power, complete dual-axis accelerometer with signal conditioned voltage outputs, all on a single monolithic IC. The ADXL311 is built using the same proven iMEMS® process used in over 180 million Analog Devices accelerometers shipped to date, with demonstrated 1 FIT reliability (1 failure per 1 billion device operating hours).

The ADXL311 measures acceleration with a full-scale range of  $\pm 2g$ . The ADXL311 can measure both dynamic acceleration (e.g., vibration) and static acceleration (e.g., gravity). The outputs are analog voltages proportional to acceleration.

### FUNCTIONAL BLOCK DIAGRAM

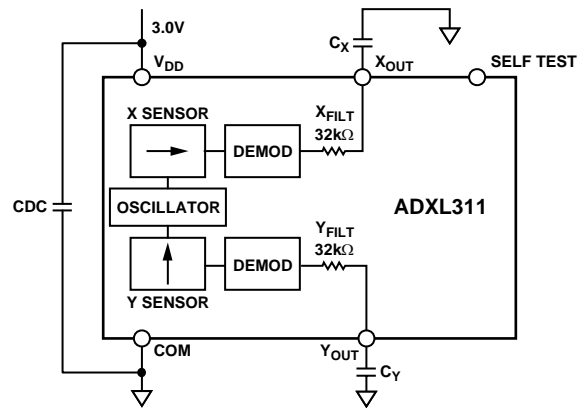

Figure 1.

The typical noise floor is  $300 \mu g/\sqrt{Hz}$ , allowing signals below 2 mg (0.1° of inclination) to be resolved in tilt sensing applications using narrow bandwidths (10 Hz).

The user selects the bandwidth of the accelerometer using capacitors  $C_X$  and  $C_Y$  at the  $X_{OUT}$  and  $Y_{OUT}$  pins. Bandwidths of 1 Hz to 3 kHz can be selected to suit the application.

The ADXL311 is available in a 5 mm × 5 mm × 2 mm, 8-terminal, hermetic LCC package.

### Rev. B

Information furnished by Analog Devices is believed to be accurate and reliable. However, no responsibility is assumed by Analog Devices for its use, nor for any infringements of patents or other rights of third parties that may result from its use. Specifications subject to change without notice. No license is granted by implication or otherwise under any patent or patent rights of Analog Devices. Trademarks and registered trademarks are the property of their respective owners.

## TABLE OF CONTENTS

Specifications.....	3	Design Trade-Offs for Selecting Filter Characteristics: The Noise/BW Trade-Off.....	8
Absolute Maximum Ratings.....	4	Using the ADXL311 with Operating Voltages Other than 3 V .....	9
ESD Caution.....	4	Using the ADXL311 as a Dual-Axis Tilt Sensor .....	9
Pin Configuration and Function Descriptions.....	5	Outline Dimensions .....	10
Typical Performance Characteristics .....	6	Ordering Guide .....	10
Theory of Operation .....	8		
Applications.....	8		

## REVISION HISTORY

### 1/05—Rev. A to Rev. B

Changes to Specifications .....	3
Change to Pin Configuration.....	5
Change to Table 5 .....	8
Changes to Self Test Section.....	8
Removed R <sub>BIAS</sub> Selection Section .....	8
Change to Design Trade-Offs for Selecting Filter Characteristics: The Noise/BW Trade-Off Section .....	8
Changes to Using the ADXL311 with Operating Voltages Other than 3 V Section .....	9
Updated Outline Dimensions .....	10
Changes to Ordering Guide .....	10

### 7/03—Rev. 0 to Rev. A

Change to OUTLINE DIMENSIONS.....	10
-----------------------------------	----

### Revision 0: Initial Version

## SPECIFICATIONS

$T_A = 25^\circ\text{C}$ ,  $V_{DD} = 3\text{ V}$ , acceleration = 0 g, unless otherwise noted.

**Table 1.**

Parameter	Conditions	Min	Typ	Max	Unit
<b>SENSOR INPUT</b>					
Measurement Range	Each axis		$\pm 2$		g
Nonlinearity	Best fit straight line		0.2		% of FS
Alignment Error <sup>1</sup>			$\pm 1$		Degrees
Alignment Error	X sensor to Y sensor		$\pm 0.1$		Degrees
Cross-Axis Sensitivity <sup>2</sup>			$\pm 2$		%
<b>SENSITIVITY</b>					
Sensitivity at $X_{FILT}$ , $Y_{FILT}$	Each axis $V_{DD} = 3\text{ V}$		174		mV/g
Sensitivity Tolerance (part to part)			$\pm 15$		%
Sensitivity Change due to Temperature <sup>3</sup>	$\Delta$ from $25^\circ\text{C}$		$\pm 0.02$		%/ $^\circ\text{C}$
<b>0 g BIAS LEVEL</b>					
0 g Voltage $X_{FILT}$ , $Y_{FILT}$	Each axis $V_{DD} = 3\text{ V}$	1.2	1.5	1.8	V
0 g Offset vs. Temperature	$\Delta$ from $25^\circ\text{C}$		$\pm 1.0$		mg/ $^\circ\text{C}$
<b>NOISE PERFORMANCE</b>					
Noise Density	@ $25^\circ\text{C}$		300		$\mu\text{g}/\sqrt{\text{Hz}}$ rms
<b>FREQUENCY RESPONSE</b>					
-3 dB Bandwidth	@ Pin $X_{FILT}$ and Pin $Y_{FILT}$		3		kHz
Sensor Resonant Frequency			5.5		kHz
<b>FILTER</b>					
$R_{FILT}$ Tolerance	32 k $\Omega$ nominal		$\pm 15$		%
Minimum Capacitance	@ Pin $X_{FILT}$ and Pin $Y_{FILT}$	1000			pF
<b>SELF TEST</b>					
$X_{FILT}$ , $Y_{FILT}$	Self Test 0 to Self Test 1		50		mV
<b>POWER SUPPLY</b>					
Operating Voltage Range		2.4		5.25	V
Quiescent Supply Current			0.4	1.0	mA
Turn-On Time <sup>4</sup>			$160 \times C_{FILT} + 4$		ms
<b>TEMPERATURE RANGE</b>					
Operating Range		0		70	$^\circ\text{C}$

<sup>1</sup> Alignment error is specified as the angle between the true and indicated axis of sensitivity.

<sup>2</sup> Cross axis sensitivity is the algebraic sum of the alignment and the inherent sensitivity errors.

<sup>3</sup> Defined as the change from ambient to maximum temperature, or ambient to minimum temperature.

<sup>4</sup>  $C_{FILT}$  in  $\mu\text{F}$ .

# ADXL311

## ABSOLUTE MAXIMUM RATINGS

Table 2.

Parameter	Rating
Acceleration (Any Axis, Unpowered)	3,500 g, 0.5 ms
Acceleration (Any Axis, Powered, $V_{DD} = 3\text{ V}$ )	3,500 g, 0.5 ms
$V_{DD}$	-0.3 V to +6 V
All Other Pins	-0.3 V to $V_{DD} + 0.3\text{ V}$
Output Short-Circuit Duration, (Any Pin to Common)	Indefinite
Operating Temperature Range	-55°C to +125°C
Storage Temperature	-65°C to +150°C

Stresses above those listed under Absolute Maximum Ratings may cause permanent damage to the device. This is a stress rating only; functional operation of the device at these or any other conditions above those indicated in the operational section of this specification is not implied. Exposure to absolute maximum rating conditions for extended periods may affect device reliability.

Table 3. Package Characteristics

Package Type	$\theta_{JA}$	$\theta_{JC}$	Device Weight
8-Lead LCC	120°C/W	20°C/W	<1.0 g

## ESD CAUTION

ESD (electrostatic discharge) sensitive device. Electrostatic charges as high as 4000 V readily accumulate on the human body and test equipment and can discharge without detection. Although this product features proprietary ESD protection circuitry, permanent damage may occur on devices subjected to high energy electrostatic discharges. Therefore, proper ESD precautions are recommended to avoid performance degradation or loss of functionality.



## PIN CONFIGURATION AND FUNCTION DESCRIPTIONS

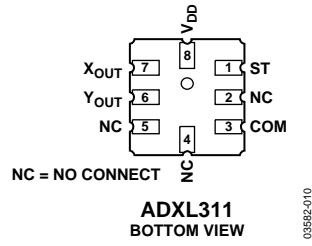

Figure 2. 8-Lead LCC Pin Configuration

Table 4. Pin Function Descriptions

Pin No.	Mnemonic	Description
1	ST	Self Test
2, 4, 5	NC	Do Not Connect
3	COM	Common
6	Y <sub>OUT</sub>	Y Channel Output
7	X <sub>OUT</sub>	X Channel Output
8	V <sub>DD</sub>	2.4 V to 5.25 V

TYPICAL PERFORMANCE CHARACTERISTICS

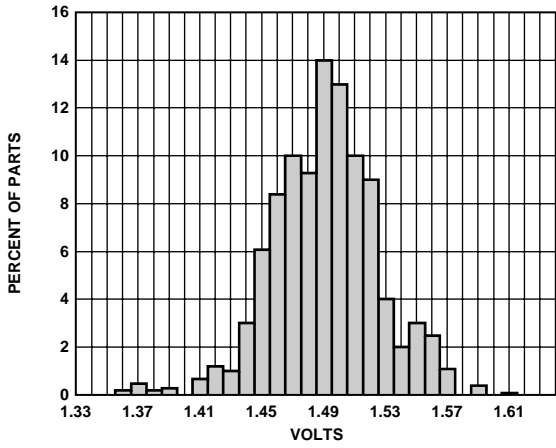

Figure 3. X-Axis 0 g BIAS Output Distribution

03582-002

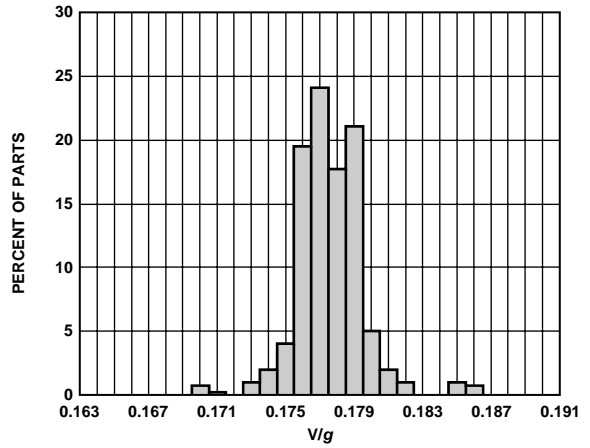

Figure 6. Y-Axis Sensitivity Distribution at  $Y_{OUT}$

03582-005

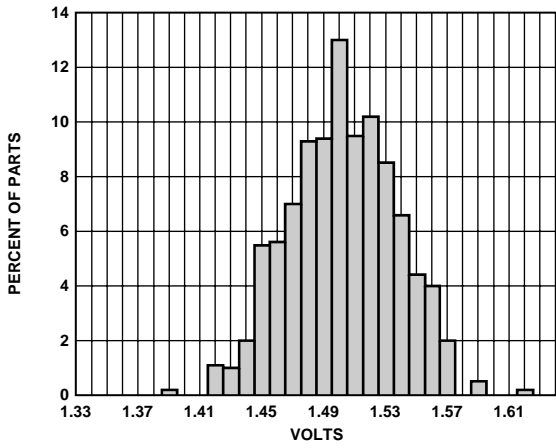

Figure 4. Y-Axis 0 g BIAS Output Distribution

03582-003

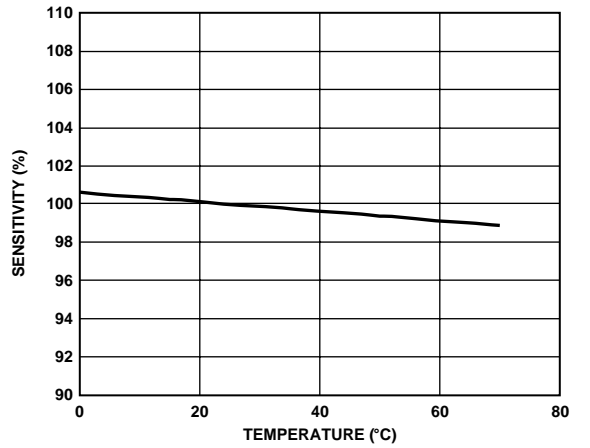

Figure 7. Normalized Sensitivity vs. Temperature

03582-006

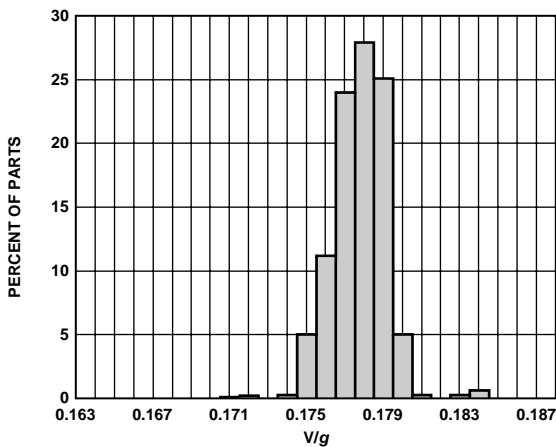

Figure 5. X-Axis Output Sensitivity Distribution at  $X_{OUT}$

03582-004

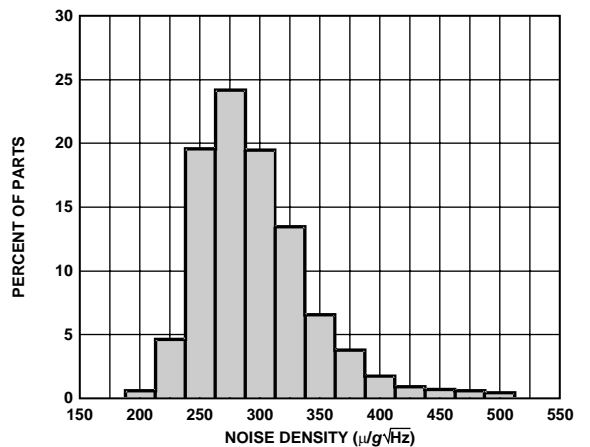
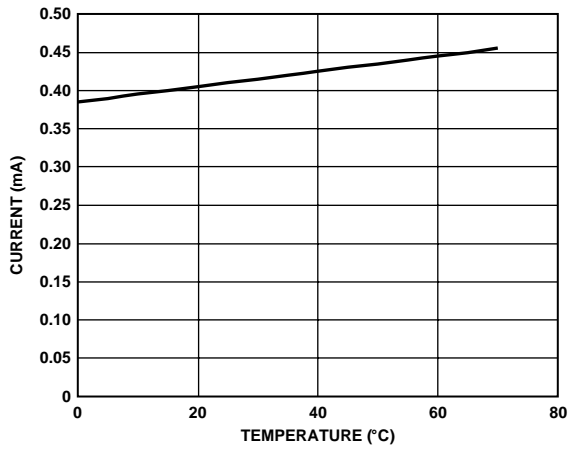

Figure 8. Noise Density Distribution

03582-007



03582-008

Figure 9. Typical Supply Current vs. Temperature

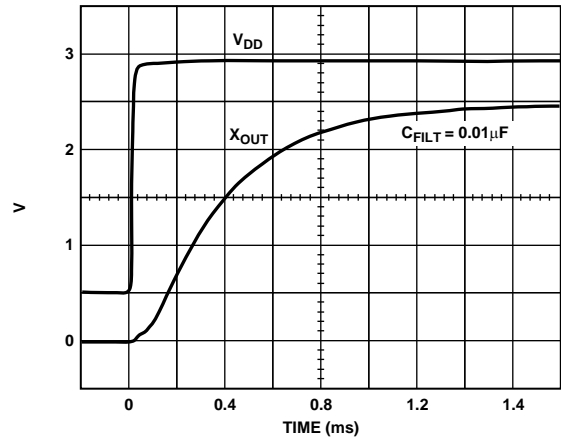

03582-008

Figure 10. Typical Turn-On Time

## THEORY OF OPERATION

The ADXL311 is a complete, dual-axis acceleration measurement system on a single monolithic IC. It contains a polysilicon, surface-micromachined sensor and signal conditioning circuitry to implement an open-loop acceleration measurement architecture. The output signals are analog voltage proportional to acceleration. The ADXL311 is capable of measuring both positive and negative accelerations to at least  $\pm 2 g$ . The accelerometer can measure static acceleration forces, such as gravity, allowing it to be used as a tilt sensor.

The sensor is a polysilicon, surface-micromachined structure built on top of the silicon wafer. Polysilicon springs suspend the structure over the surface of the wafer and provide a resistance against acceleration forces. Deflection of the structure is measured using a differential capacitor that consists of independent fixed plates and central plates attached to the moving mass. The fixed plates are driven by  $180^\circ$  out-of-phase square waves. Acceleration deflects the beam and unbalances the differential capacitor, resulting in an output square wave whose amplitude is proportional to acceleration. Phase-sensitive demodulation techniques are then used to rectify the signal and determine the direction of the acceleration.

The output of the demodulator is amplified and brought off chip through a  $32\text{ k}\Omega$  resistor. At this point, the user can set the signal bandwidth of the device by adding a capacitor. This filtering improves measurement resolution and helps prevent aliasing.

### APPLICATIONS

#### Power Supply Decoupling

For most applications, a single  $0.1\ \mu\text{F}$  capacitor, CDC, adequately decouples the accelerometer from noise on the power supply. However, in some cases, particularly where noise is present at the  $140\text{ kHz}$  internal clock frequency (or any harmonic thereof), noise on the supply can cause interference on the ADXL311 output. If additional decoupling is needed, a  $100\ \Omega$  (or smaller) resistor or ferrite beads can be inserted in the supply line of the ADXL311. Additionally, a larger bulk bypass capacitor (in the  $1\ \mu\text{F}$  to  $4.7\ \mu\text{F}$  range) can be added in parallel to CDC.

#### Setting the Bandwidth Using $C_X$ and $C_Y$

The ADXL311 has provisions for band limiting the  $X_{\text{OUT}}$  and  $Y_{\text{OUT}}$  pins. Capacitors must be added at these pins to implement low-pass filtering for antialiasing and noise reduction. The equation for the  $-3\text{ dB}$  bandwidth is

$$F_{-3\text{ dB}} = 1 / (2\pi(32\text{ k}\Omega) \times C_{(X,Y)})$$

or, more simply,

$$F_{-3\text{ dB}} = 5\ \mu\text{F} / C_{(X,Y)}$$

The tolerance of the internal resistor ( $R_{\text{FILT}}$ ) can vary, typically as much as  $\pm 15\%$  of its nominal value of  $32\text{ k}\Omega$ , and the bandwidth varies accordingly. A minimum capacitance of  $1000\text{ pF}$  for  $C_X$  and  $C_Y$  is required in all cases.

**Table 5. Filter Capacitor Selection,  $C_X$  and  $C_Y$**

Bandwidth	Capacitor ( $\mu\text{F}$ )
10 Hz	0.47
50 Hz	0.10
100 Hz	0.05
200 Hz	0.027
500 Hz	0.01

#### SELF TEST

The ST pin controls the self-test feature. When this pin is set to  $V_{\text{DD}}$ , an electrostatic force is exerted on the beam of the accelerometer. The resulting movement of the beam allows the user to test if the accelerometer is functional. The typical change in output is  $290\text{ mg}$  (corresponding to  $50\text{ mV}$ ). This pin can be left open circuit or connected to common in normal use.

#### DESIGN TRADE-OFFS FOR SELECTING FILTER CHARACTERISTICS: THE NOISE/BW TRADE-OFF

The accelerometer bandwidth selected ultimately determines the measurement resolution (smallest detectable acceleration). Filtering can lower the noise floor, which improves the resolution of the accelerometer. Resolution is dependent on the analog filter bandwidth at  $X_{\text{OUT}}$  and  $Y_{\text{OUT}}$ .



The output of the ADXL311 has a typical bandwidth of 3 kHz. The user must filter the signal at this point to limit aliasing errors. The analog bandwidth must be no more than half the A/D sampling frequency to minimize aliasing. The analog bandwidth can be further decreased to reduce noise and improve resolution.

The ADXL311 noise has the characteristics of white Gaussian noise that contribute equally at all frequencies and are described in terms of  $\mu\text{g}/\sqrt{\text{Hz}}$ , i.e., the noise is proportional to the square root of the bandwidth of the accelerometer. It is recommended that the user limits the bandwidth to the lowest frequency needed by the application to maximize the resolution and dynamic range of the accelerometer.

With the single-pole roll-off characteristic, the typical noise of the ADXL311 is determined by

$$\text{RMS Noise} = (300 \mu\text{g} / \sqrt{\text{Hz}}) \times (\sqrt{BW} \times 1.6)$$

At 100 Hz the noise will be

$$\text{RMS Noise} = (300 \mu\text{g} / \sqrt{\text{Hz}}) \times (\sqrt{100} \times 1.6) = 3.8 \text{ mg}$$

Often the peak value of the noise is desired. Peak-to-peak noise can only be estimated by statistical methods. Table 6 shows the probabilities of exceeding various peak values, given the rms value.

**Table 6. Estimation of Peak-to-Peak Noise**

Peak-to-Peak Value	% of Time That Noise Exceeds Nominal Peak-to-Peak Value
2 × rms	32
4 × rms	4.6
6 × rms	0.27
8 × rms	0.006

The peak-to-peak noise value gives the best estimate of the uncertainty in a single measurement. Table 7 gives the typical noise output of the ADXL311 for various  $C_X$  and  $C_Y$  values.

**Table 7. Filter Capacitor Selection,  $C_X$  and  $C_Y$**

Bandwidth (Hz)	$C_X, C_Y$ ( $\mu\text{F}$ )	RMS Noise (mg)	Peak-to-Peak Noise Estimate (mg)
10	0.47	1.2	7.2
50	0.1	2.7	16.2
100	0.047	3.8	22.8
500	0.01	8.5	51

## USING THE ADXL311 WITH OPERATING VOLTAGES OTHER THAN 3 V

The ADXL311 is tested and specified at  $V_{DD} = 3 \text{ V}$ ; however, it can be powered with  $V_{DD}$  as low as 2.4 V, or as high as 5.25 V. Some performance parameters change as the supply voltage varies.

The ADXL311 output is ratiometric, so the output sensitivity (or scale factor) varies proportionally to the supply voltage. At  $V_{DD} = 5 \text{ V}$ , the output sensitivity is typically 312 mV/g.

The 0 g bias output is also ratiometric, so the 0 g output is nominally equal to  $V_{DD}/2$  at all supply voltages.

The output noise is not ratiometric, but absolute in volts; therefore, the noise density decreases as the supply voltage increases. This is because the scale factor (mV/g) increases while the noise voltage remains constant.

The self-test response is roughly proportional to the square of the supply voltage. At  $V_{DD} = 5 \text{ V}$ , the self-test response is approximately equivalent to 750 mg (typical).

The supply current increases as the supply voltage increases. Typical current consumption at  $V_{DD} = 5 \text{ V}$  is 750  $\mu\text{A}$ .

## USING THE ADXL311 AS A DUAL-AXIS TILT SENSOR

One of the most popular applications of the ADXL311 is tilt measurement. An accelerometer uses the force of gravity as an input vector to determine the orientation of an object in space.

An accelerometer is most sensitive to tilt when its sensitive axis is perpendicular to the force of gravity, i.e., parallel to the earth's surface. When the accelerometer is oriented parallel to the gravity vector, i.e., near its +1 g or -1 g reading, the change in output acceleration per degree of tilt is negligible. When the accelerometer is perpendicular to gravity, its output changes nearly 17.5 mg per degree of tilt, but at 45° degrees, it changes only 12.2 mg per degree, and resolution declines.

### Dual-Axis Tilt Sensor: Converting Acceleration to Tilt

When the accelerometer is oriented so both its X-axis and Y-axis are parallel to the earth's surface, it can be used as a two-axis tilt sensor with a roll axis and a pitch axis. Once the output signal from the accelerometer has been converted to an acceleration that varies between -1 g and +1 g, the output tilt in degrees is calculated as follows:

$$\text{Pitch} = \text{ASIN}(A_X / 1 \text{ g})$$

$$\text{Roll} = \text{ASIN}(A_Y / 1 \text{ g})$$

Be sure to account for overranges. It is possible for the accelerometers to output a signal greater than  $\pm 1 \text{ g}$  due to vibration, shock, or other accelerations.

# ADXL311

## OUTLINE DIMENSIONS

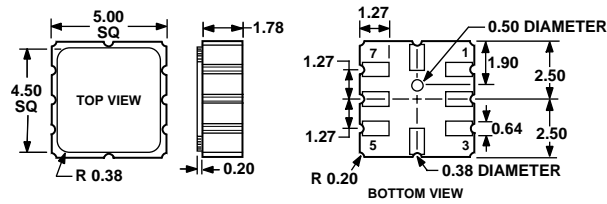

Figure 11. 8-Terminal Ceramic Leadless Chip Carrier [LCC]  
(E-8)  
Dimensions shown in millimeters

## ORDERING GUIDE

Model	Number of Axes	Specified Voltage	Temperature Range	Package Description	Package Option
ADXL311JE	2	3 V	0°C to 70°C	8-Lead Ceramic Leadless Chip Carrier	E-8
ADXL311JE-REEL	2	3 V	0°C to 70°C	8-Lead Ceramic Leadless Chip Carrier	E-8
ADXL311EB				Evaluation Board	

**NOTES**

**ADXL311**

**NOTES**

